

SIMRAD

AP70 MK2

Operator Manual

ENGLISH



Preface

Disclaimer

As Navico is continuously improving this product, we retain the right to make changes to the product at any time which may not be reflected in this version of the manual. Please contact your nearest distributor if you require any further assistance.

It is the owner's sole responsibility to install and use the equipment in a manner that will not cause accidents, personal injury or property damage. The user of this product is solely responsible for observing maritime safety practices.

NAVICO HOLDING AS AND ITS SUBSIDIARIES, BRANCHES AND AFFILIATES DISCLAIM ALL LIABILITY FOR ANY USE OF THIS PRODUCT IN A WAY THAT MAY CAUSE ACCIDENTS, DAMAGE OR THAT MAY VIOLATE THE LAW.

This manual represents the product as at the time of printing. Navico Holding AS and its subsidiaries, branches and affiliates reserve the right to make changes to specifications without notice.

Governing language

This statement, any instruction manuals, user guides and other information relating to the product (Documentation) may be translated to, or has been translated from, another language (Translation). In the event of any conflict between any Translation of the Documentation, the English language version of the Documentation will be the official version of the Documentation.

Trademarks

Navico® is a registered trademark of Navico Holding AS.

Simrad® is used by license from Kongsberg.

Copyright

Copyright © 2019 Navico Holding AS.

Warranty

The warranty card is supplied as a separate document. In case of any queries, refer to the brand website of your unit or system:

www.navico-commercial.com

Compliance statements

Navico declare under our sole responsibility that the product conforms with the requirements of:

- C-tick
- CE under EMC Directive 2014/30/EU
- European Council Directive 2014/90/EU on Marine Equipment modified by Commission Implementing Regulation (EU) 2018/773 (MED) - Wheelmark

→ **Note:** The AP70 MK2 system is Wheelmark approved only when installed according to the relevant AP70 MK2 MED-B certificate.

The relevant declaration of conformity and certificates are available in the product's section at the following website:

www.navico-commercial.com

About this manual

This manual is a reference guide for operating the unit. It assumes that all equipment is installed and configured, and that the system is ready to use.

Images used in this manual might not exactly match the screen on your unit.

Intended audience

This manual is written for system operators.

The manual assumes that the reader has basic knowledge about this type of equipment in regards to:

- operation
- nautical terminology and practices

Important text conventions

Important text that requires special attention from the reader is emphasized as follows:

→ **Note:** Used to draw the reader's attention to a comment or some important information.

⚠ Warning: Used when it is necessary to warn personnel that they should proceed carefully to prevent risk of injury and/or damage to equipment/personnel.

Manual version

This manual is written for software version 1.0. The manual is continually updated to match new software releases. The latest available manual version can be downloaded from the following website:

- www.navico-commercial.com

Change log

Part no	Date and description
988-12375-001	2019-Jan-11
	First version.

Contents

7 Introduction

- 7 Front panel keys
- 8 USB port
- 9 The autopilot page

11 Basic operation

- 11 Safe operation with the autopilot
- 11 External system selector
- 11 External EVC override (SG05 PRO)
- 12 The Pendulum feature
- 12 Turning the system ON and OFF
- 12 Taking command
- 13 The menu system
- 13 Display setup
- 14 Selecting autopilot mode
- 14 Selecting work profile
- 14 Working with thrusters

17 Delegation of control in multiple station systems

- 17 Steering stations
- 17 Open systems
- 18 Master systems

20 Autopilot modes

- 20 External system selector
- 20 Hand steering
- 20 Automatic modes
- 25 NAV mode
- 27 Controlling steering performance in automatic and navigational modes
- 29 Simulator mode

30 Work profiles

- 30 Predefined profiles
- 30 Creating a new work profile
- 30 User configurable settings

36 The alert system

- 36 Alert message types
- 36 Alert indication
- 37 Acknowledging a message
- 37 Alert dialogs
- 38 Setting the alert and warning limits
- 38 Fallback and failures during automatic steering
- 40 Possible alerts and corrective action

44 Maintenance

- 44 Preventive maintenance
- 44 Cleaning the display unit
- 44 Cleaning the media port door
- 44 Checking the connectors
- 44 Restoring factory default settings
- 44 Backup and restore of system data
- 45 Software updates

47 Menu overview

- 47 Quick menus

48 Settings

50 Terms and abbreviations

1

Introduction

Front panel keys

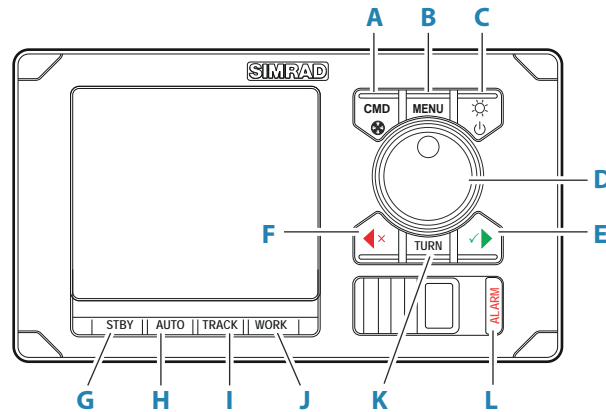

A Command/Thruster key

- Press to take/request command
- Press and hold to activate/deactivate available thrusters

B Menu key

- Press once to display the Quick menu
- Press twice to show the Settings menu

C Power/Brilliance key

- Press to display the Display setup dialog
- Press and hold to turn the unit to sleep mode

D Rotary knob

Menu and dialog operation:

- Turn to move up and down in menus and dialogs
- Turn to adjust a value
- Press to select a menu option and to enter the next menu level

In Standby and NFU mode:

- Press and hold to activate Follow up (FU) mode

In FU mode:

- Turn to set the rudder angle

In automatic modes:

- Turn to change the set heading/set course, press to re-activate automatic mode with current heading/course as reference

E Starboard (confirm) key

Menu and dialog operation

- press to confirm/enter next menu level

In Standby mode:

- press to activate NFU mode

In automatic modes:

- press to change set heading/set course to starboard

F Port (cancel) key

Menu and dialog operation:

- press to cancel and to return previous menu level
- press and hold to close the menu

In Standby mode:

- Press to activate NFU mode

In automatic modes:

- press to change set heading/set course to port

G Standby key

- Press to turn the autopilot to Standby mode

H Auto key

- Press once to activate Auto or NoDrift mode
- Re-press to toggle between the Auto and NoDrift mode options

I Track key

- Press to activate Nav mode

J Work key

- Press to display the Work quick menu

K Turn key

- Press to display the Turn quick menu

L Alarm key

- Press to display the list of active alerts

USB port

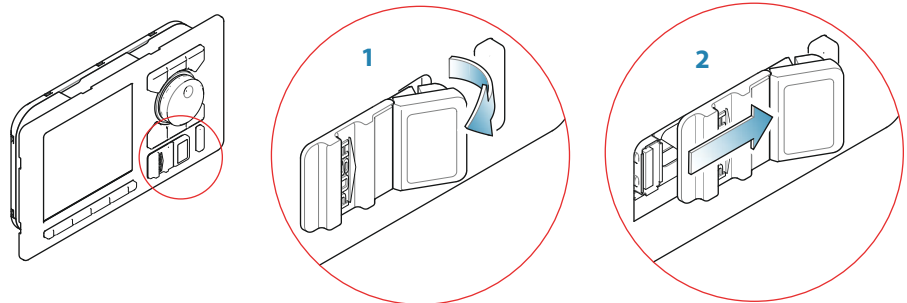

The USB port can be used to:

- connect a storage device

The USB devices should be standard PC compatible hardware.

When not in use, the protective door should always be securely shut to prevent possible water ingress.

The autopilot page

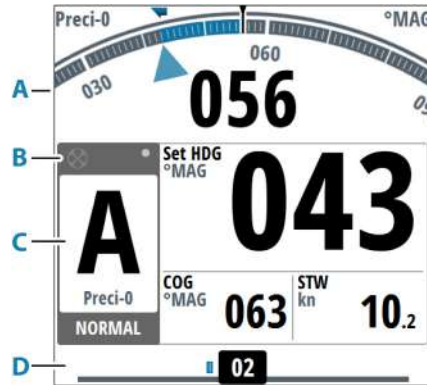

- A** Heading repeater
- B** Status panel
- C** Mode info panel
- D** Rudder bar

Heading repeater

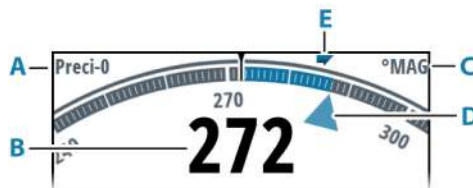

- A** Heading source
- B** Current heading
- C** Heading unit (True or Magnetic)
- D** Set heading
- E** Rate of Turn (ROT) indicator

Status panel

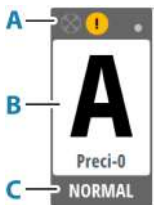

The panel includes status icons (**A**), active mode with steering reference (**B**), and active profile (**C**).

The following mode abbreviations are used:

- **S**: Standby
- **A**: AUTO
- **FU**: Follow-up
- **ND**: No Drift
- **NFU**: Non-Follow Up
- **N**: NAV
- S-turn icon

If the autopilot is operated from another control unit, the passive icon is shown in the mode indication field.

If the autopilot is controlled by an external system selector, the mode indication will be replaced as below.

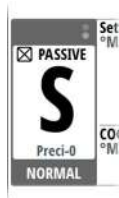



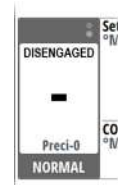

Passive control unit



Autopilot disengaged by external system selector

Available status icons are shown below. Only active icons are visible.

-  Icon available if a thruster is installed. The icon will be shaded when the thruster is deactivated for steering
-  Active alert. Red icon for alarms, yellow for warning. See more details in *"The alert system"* on page 36.
-  Locked control unit
-  Picture freeze indicator. Two dots alternate slowly to show that the screen is alive and that information from sensors is updated

Mode info panel

The panel contains mode specific content and varies with the operational mode. See *"Autopilot modes"* on page 20 onwards for more details.

If a thruster is available and active, the mode info panel will be split to show thruster information.



No thruster available



Thruster in use

→ **Note:** If sensor input is missing, the numbers will be replaced with hyphens.

Rudder bar

Rudder position indicator with digital and analog readout. Direction indicator (**A**) is shown when rudder movement is commanded and rudder feedback is available.



2

Basic operation

Safe operation with the autopilot

⚠ Warning: An autopilot is a useful navigational aid, but DOES NOT replace a human navigator.

⚠ Warning: Ensure the autopilot has been installed correctly, commissioned and calibrated before use.

Do not use automatic steering when:

- In heavy traffic areas or in narrow waters
- In poor visibility or extreme sea conditions
- When in areas where use of an autopilot is prohibited by law

When using an autopilot:

- Do not leave the helm unattended
- Do not place any magnetic material or equipment near the heading sensor used by the autopilot system
- Verify at regular intervals the course and position of the vessel
- Always switch the autopilot to standby and reduce speed in due time to avoid hazardous situations

Autopilot alerts

For safety reasons it is recommended to turn on all autopilot alerts when operating the autopilot.

For more information, refer to *"The alert system"* on page 36.

External system selector

IMO resolution MSC.64(67) and other regulations require that an external switch is used for controlling change-over from manual to automatic steering.

The mode descriptions in this manual assumes that an external system selector has opened for autopilot operation, or that no external selector is installed.

Manual steering

When an external system selector is set to manual steering, the autopilot will be disengaged. The control unit will display information as in Standby mode. It is not possible to change to FU, NFU or to any automatic mode. The menus can however be used, alerts acknowledged and illumination adjusted.

When the autopilot is disengaged by an external switch, this will be indicated in the mode display.

Autopilot operation

When the external selector is set to automatic steering, the autopilot will go directly to AUTO heading mode with present heading as set reference. The autopilot can then be used in all operational modes.

External EVC override (SG05 PRO)

You may at any time, irrespective of the autopilot mode, take manual control of the steering by means of the helm. The autopilot will then go to Standby mode and display Override to indicate the steering is from the helm. Autosteering can be resumed by pressing the **AUTO** or the **WORK** key.

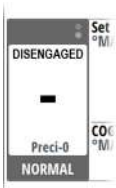

The Pendulum feature

The pendulum feature is intended for pendulum ferries where it is required to turn the heading 180° when the vessel is going backwards. The feature can be included in systems equipped with SD80 or AD80 boards.

The pendulum feature is activated by using an external switch. When the contact is closed, the heading from the main compass and the monitor compass will change 180°. The heading is changed before heading data enters the CAN bus network, and all devices on the bus will pick up the modified heading.

→ **Note:** The system must be configured for the pendulum feature as described in the separate installation manual.

Turning the system ON and OFF

Turning ON

Press the standby/brilliance key to turn the system ON.
The system will be ON as long as power is connected.

Switch the system to sleep mode

Press and hold the Standby/Brilliance key on an active control unit to switch the system to sleep mode.

During the shut-down procedure the system will automatically go to Standby mode before it is turned off.

→ **Note:** The Standby/Brilliance key will remain lit on units that are in sleep mode. To stop the system from drawing current a separate breaker should be installed.

Taking command

You can take command from any control unit and/or remote by pressing the Command key. In an open system (no command transfer restrictions) you will get immediate control from the control unit requesting command. A steering handle without a Command key will get control when the lever is operated.

In a multi-station system with active lock function, the command request must be confirmed on the active control unit.

Active/passive units

In a system including more than one control unit and/or remote units, only one unit can be in control at a time. All other units will be passive.

A passive unit is indicated with a passive icon in the mode status field.

On a passive/locked unit illumination can be adjusted, alert sound can be locally silenced, and the Command key can be used for requesting command. All other functions are unavailable.

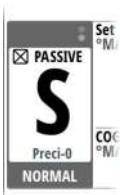

The menu system

Quick menus

The system includes 3 different quick menus:

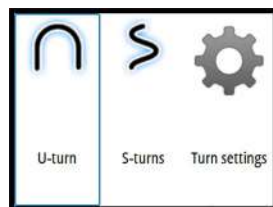
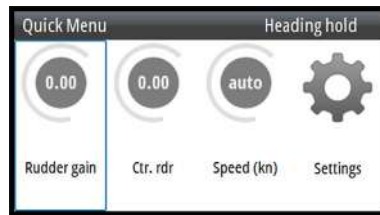

- Mode Quick menu, activated by pressing the Menu key. See *"Autopilot modes"* on page 20.
- Work profile Quick menu, activated by pressing the Work key. See *"Selecting work profile"* on page 14 and *"Work profiles"* on page 30.
- Turn Quick menu, activated by pressing the Turn key. See *"Turn patterns"* on page 23.

The Settings menu

The Settings menu are used for system setup and configuration.



To access the Settings menu:

- press the Menu key twice
- select the Settings option in the Mode Quick menu

Display setup

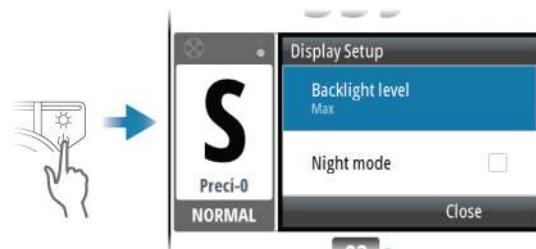

The display setup can be adjusted at any time from the Display setup dialog.

To access the dialog:

- Press the power key
- **Note:** All changes made to the display setup will apply to all units belonging to the same display group. For more information about network groups, refer to the separate Installation manual.

Backlight level

Adjusts the backlight level.

When the dialog is active, you can cycle the preset backlight levels by short presses on the power key.

Night mode color

Sets the night mode color palette.

Selecting autopilot mode

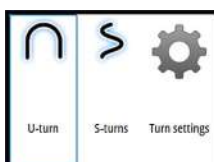
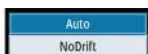
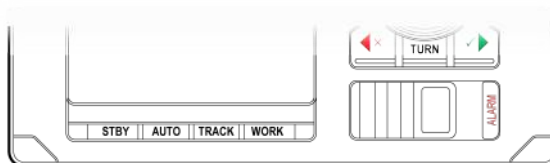

- Standby mode or Nav mode: press the Standby or Track key
- Auto mode or NoDrift mode: press the Auto key
 - last active mode (Auto or NoDrift) is activated immediately, and the mode pop-up menu is displayed
 - repeat pressing the Auto key to toggle the pop-up menu options. The selection times out and triggers the mode shift
- Turn mode: press Turn key, then select the turn option from the Turn Quick menu
- NFU (Non Follow Up) mode: press the port or starboard key when the system is in Standby mode
- FU (Follow Up) mode: press and hold the rotary knob when the system is in Standby or NFU mode

See more details in *"Autopilot modes"* on page 20.

Selecting work profile

The autopilot can be set up with different profiles associated with different work modes. See more details in *"Work profiles"* on page 30.

1. Press the Work key to display the Work quick menu
2. Repeat pressing the Work key or use the rotary knob to select preferred profile
 - The selection times out and triggers the work profile shift. You can also confirm your selection by pressing the rotary knob.

The name of the work profile in use is displayed in the mode status panel.

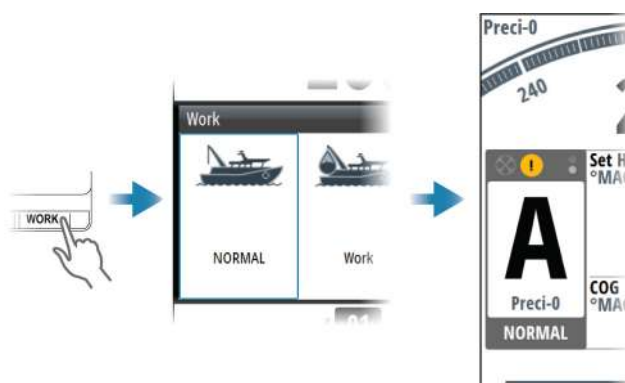

Working with thrusters

Thruster(s) can be connected to the autopilot system.

For number of thrusters that can be connected, refer to the specifications in the separate Installation manual for the autopilot system.

The thruster(s) can be configured to different work profiles, and the work profile in use will then decide if the vessel can be controlled by rudder, thruster(s), or both rudder and thruster(s).

Thruster settings

Two settings affect how the thrusters are used by the autopilot:

- **Thruster inhibit** speed - set during dockside setup
 - This setting will turn the thrusters OFF when the vessel is running above a set speed limit
- The **Thruster assist** function - set when configuring the thrusters for the work profiles
 - ON: the thrusters will automatically be used by the autopilot system. If the thrusters are turned off when the vessel increases inhibited speed, the thrusters will automatically be turned on again when the speed goes below the inhibited limit
 - OFF: you must manually turn thrusters ON

For more information see "*User configurable settings*" on page 30.

Activating and de-activating the thruster

If a thruster is activated for a profile, the thruster can manually be turned OFF and ON.

To turn the thruster ON and OFF:

- press and hold the Command key

A popup with slide bar is displayed to indicate change in thruster status.

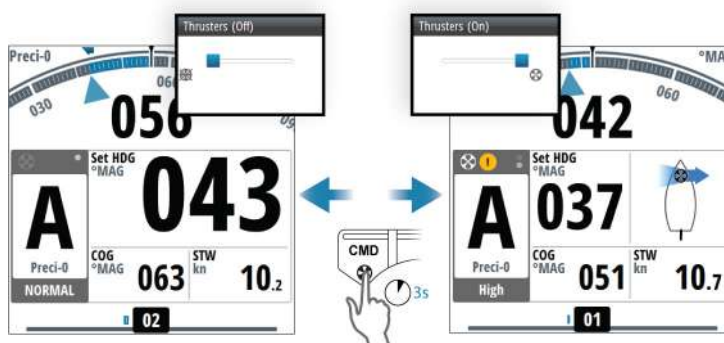

Thruster presentation

When a thruster is installed and activated in the work profile, the thruster status icon and the thruster information in the mode info panel are as shown below.



- Thruster available for present work profile, no thrust applied



- Thruster in use. Image including thrust direction



- Thruster manually deselected
- Thruster unavailable (vessel speed is above inhibit limit)

3

Delegation of control in multiple station systems

Steering stations

An autopilot system with multiple stations can be set up with different steering stations. This setting is done during installation of the system, and the separate autopilot Installation manual details how to define network groups.

The network group Station settings determines lock/unlock and command transfer principle between active and passive control units. Based on this setting the system is defined as an open system or a master system as described in the following sections.

On a locked unit you can only adjust illumination and silence an alert locally. All other functions are unavailable.

Open systems

In a default installation the system is open, and control is accessible from every control unit connected to the autopilot system. One control unit is active and provides the user with access to all functions. All remaining control units are inactive and have no effect on course changes. A single press on the Command key on an inactive control unit will allow transfer of command and make the unit active. On steering levers without a command key, command is taken by moving the lever.

Locking and unlocking units in an open system

You can temporarily lock units in an open system if you want to avoid accidental control from another control unit.

An active control unit can lock and unlock all passive control units.

1. Activate the lock function from any active control unit by a single press on the Command key
2. Deactivate the function with a second press on the Command key

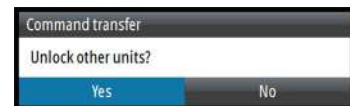
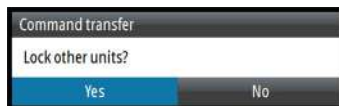

Active locking function is indicated with a lock symbol on both active and passive units.

Taking command from a locked unit in an Open system

1. Press the Command key on the locked unit
 - A dialog will be shown on the unit requesting command (**A**)
 - A command request dialog will be shown on the active unit, accompanied by a 2 second sound (**B**)



2. Accept the command request on the active unit
 - All passive units will be opened for command transfer, indicated as below
 - The lock function will be deactivated, and the lock symbol removed from all units

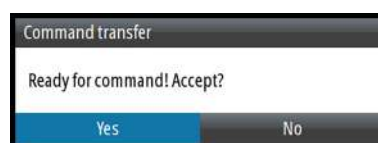

3. Take command on selected remote unit

Master systems

The international standard for heading control systems (ISO 11674/16329) requires controlled command transfer when remote stations are provided. The delegation of control to the remote station and the return of control shall be incorporated in the autopilot system, and shall avoid unintended operation from a remote station.

To fulfil this requirement the AP70 MK2 system includes a Master function. This is used in Wheelmarked systems where you permanently want to control command transfer to remote stations.

In a Master system, one steering station is defined as the Master station. There can be several control units in a master station, but only one of them can be set as the Master unit.

All units included in the master station will be unlocked, and command transfer within the master group will be as in an open system.

Units not included in the master station will be locked. It is not possible to take command from units outside the master station unless the master control unit opens for this. All units outside the master station will have a lock symbol.

In the illustration the main bridge is defined as master station. One QS80, and two AP70 MK2 control units are included in the master station. One of the AP70 MK2 control units is defined as the Master unit. The illustration includes network group settings for each unit, showing how the units are defined as part of different network stations.

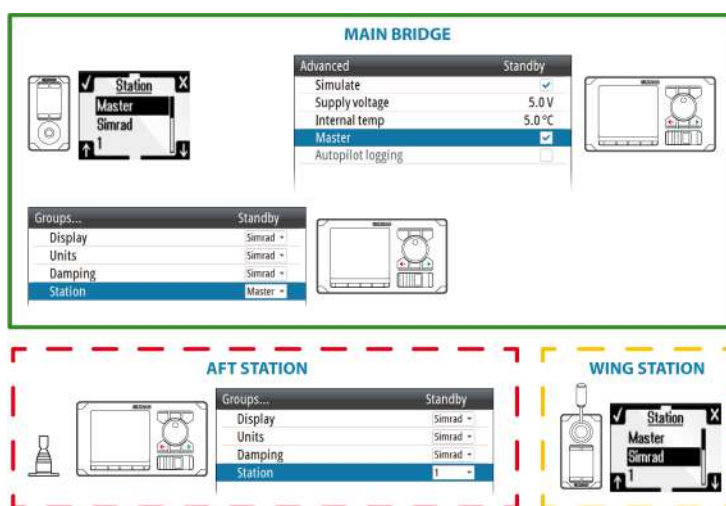

Defining a Master system

A master station is usually defined and units assigned to the master station during system setup. Refer to the separate autopilot installation manual for details.

Groups...	Standby
Display	Simrad ▾
Units	Simrad ▾
Damping	Simrad ▾
Station	Master ▾

→ **Note:** When a network group Station is set to Master, one control unit in this steering station has to be defined as the Master unit.

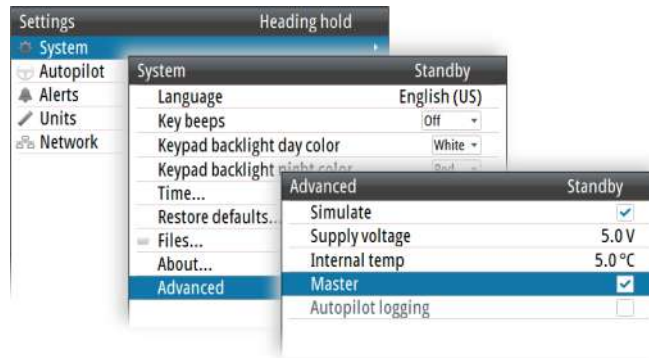

In a Master system command can be transferred to a remote unit either by opening the system for remote operation from the Master unit, or by requesting command from one of the remote units.

→ **Note:** You can at any time return to control from the Master station by pressing the Command key on one of the units in the master station.

Opening a Master system for operation from a remote unit

1. Press the Command key on the Master unit

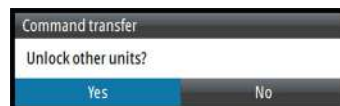

2. Accept the command request on the master unit
 - The system will now be open and command can be taken from any station
3. Take command on the selected remote by pressing the Command key
 - Command will be transferred to this remote, accompanied by a 2 second sound
 - All other remote units will return to locked status

Taking command from a locked unit in a Master system

1. Press the Command key on the locked unit
 - A dialog will be shown on the unit requesting command (A)
 - A command request dialog will be shown on the master unit (B)

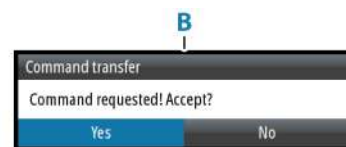
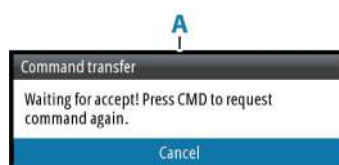

2. Accept the command request on the master unit
 - The requesting unit will now be opened for command transfer. Other units will remain locked

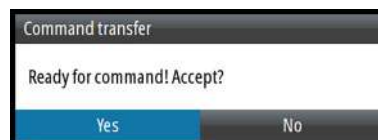

3. Press the Command key on the unit requesting command
 - Command will be transferred to this unit, accompanied by a 2 seconds sound

4

Autopilot modes

The autopilot has several steering modes. The number of modes and features within the mode depend on the autopilot computer, the boat type and available inputs.

External system selector

An external switch can be used for controlling change over from manual to automatic steering.

The mode descriptions in the following pages assumes that an external system selector has opened for autopilot operation, or that no external selector is installed.

Hand steering

Standby mode

Standby mode is used when you steer the boat at the helm.

- Switch to Standby mode by pressing the **STBY** key.

→ **Note:** If sensor data vital for autopilot operation (e.g. rudder response) is lost when the autopilot is running in an automatic mode, the system will automatically switch to Standby mode.



Non-Follow Up (NFU) mode

In NFU mode you can use the port and starboard keys on the controller to operate the rudder. The rudder will move as long as the key is pressed.

- Switch to NFU mode by pressing one of the port or starboard keys when the autopilot is in Standby mode or FU mode.



Follow-up (FU) mode

In FU mode you turn the rotary knob to adjust the set rudder angle.

The rudder will move to the commanded angle and then stop.

- Switch to FU mode from Standby mode or NFU mode by pressing and holding the rotary knob.



Quick menus in STBY, FU and NFU mode



From the Quick menu in Standby, NFU and FU you can change sources used for steering, display active alerts and set manual speed.

Automatic modes

This autopilot system includes two automatic modes:

- Auto compass mode keeps the vessel on set heading
- NoDrift mode combines heading and position information, and keeps the vessel on a straight track

You toggle between Auto and NoDrift mode by repeated presses on the Auto key. The selection times out and triggers the mode shift. You can also confirm your selection by pressing the Starboard key or the rotary knob.

Defining the heading/course change for the arrow keys

By default the set heading (Auto mode) and set course (NoDrift mode) will change 1° each time you press the port or starboard key. You can change this increment setting from the Turn settings dialog. The dialog is activated from the Turn Quick menu and from the Autopilot settings dialog.



The turn preset function

The system includes a turn preset feature for Auto and NoDrift mode. This allows for setting the new heading/course, turn radius and turn type before the turn starts. The function gives a more precise starting point for the turn, and it also avoids unintended heading/course changes when accidentally turning the rotary knob.

→ **Note:** The port and starboard keys will always give immediate action, also when the turn preset function is active.

Enabling the turn preset function

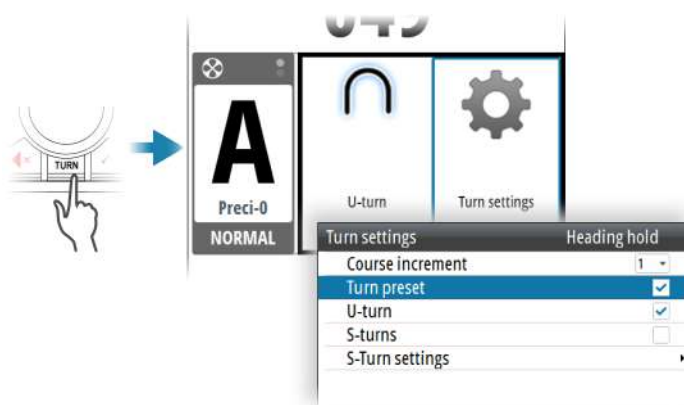

Using the turn preset function

When in Auto or NoDrift mode:

1. Turn the rotary knob to display the turn preset dialog
2. Set the new heading/new course, radius and turn type in the dialog
3. When the vessel reaches the selected turn point, initiate the turn by selecting the Activate button (A)
 - The pre-set heading/course will immediately be shown in the course display
 - The dialog will change to show turn adjust options. If the settings are adjusted the changes will take effect immediately

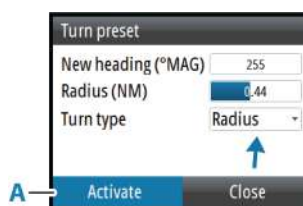

You can close the dialog at any time without disturbing the pre-setting or the execution of a turn. If closed, the dialog is recalled by turning the rotary knob.

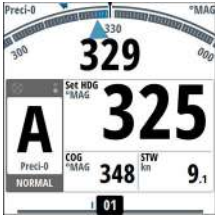

AUTO mode (Heading hold)

In AUTO mode the autopilot issues rudder commands required to steer the vessel automatically on a set heading. In this mode the autopilot does not compensate for any drifting caused by current and/or wind (**A**).

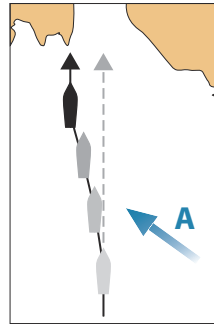

- Switch to AUTO mode by pressing the **AUTO** key. Repress the key to highlight the **Auto** option in the pop-up menu

When the mode is activated, the autopilot selects the current boat heading as the set heading.

Changing set heading in AUTO mode

You adjust the set heading by turning the rotary knob or by pressing the port or starboard keys.

An immediate heading change takes place. The new heading is maintained until a new heading is set.

Heading capture

When the vessel is turning in AUTO mode, an instant re-press on the **AUTO** key or the rotary knob activates the heading capture function. This will automatically cancel the turn, and the vessel will continue on the heading read from the compass the very moment you pressed the **AUTO** key or the rotary knob.

Temporary heading changes

If you need to avoid an obstacle when in **AUTO** mode, you can press the **STBY** key and power steer or use the helm until the obstacle is passed.

If you re-press the **AUTO** key within 3 minutes you can select to continue on previous set heading. If you don't respond within 3 seconds the menu will disappear, and the autopilot will go to **AUTO** mode with current heading as set heading.

Quick menu in AUTO mode



From the Quick menu in AUTO mode you can change rudder parameters and set manual speed.

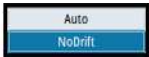

NoDrift mode

→ **Note:** It is not possible to select NoDrift mode if GPS position and heading information is missing.

In NoDrift mode the vessel is steered along a calculated track line, from present position and in a direction set by the user. If the vessel is drifting away from the track line due to current and/or wind (**A**), the vessel will follow the line with a crab angle.

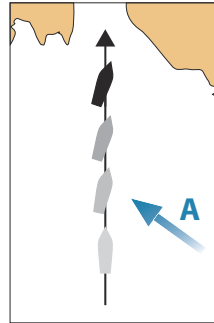

- Switch to NoDrift mode by pressing the **AUTO** key. Repress the key to highlight the NoDrift option in the pop-up menu

When the mode is activated, the autopilot will draw an invisible track line based on current heading from the vessel's position.

The autopilot will now use the position information to calculate the cross track distance, and automatically steer along the calculated track.

Changing set course in NoDrift mode

You adjust the set course by turning the rotary knob or by pressing the port or starboard keys.

An immediate course change takes place. The new course is maintained until a new course is set.

Dodging

If you need to avoid an obstacle when using NoDrift mode, you can set the autopilot to Standby mode and power steer or use the helm until the obstacle is passed.

If you return to NoDrift mode within 60 seconds you can select to continue on previous set bearing line.

If you do not respond, the dialog disappears and the autopilot goes to NoDrift mode with current heading as set bearing line.

Quick menu in NoDrift mode



From the Quick menu in NoDrift mode you can change the track response, rudder parameters and set manual speed.

Turn patterns

The system includes the following turn patterns:

- U-turn
- S-turns (optional)

Starting and stopping a turn

To start a turn:

- Select the port or starboard button

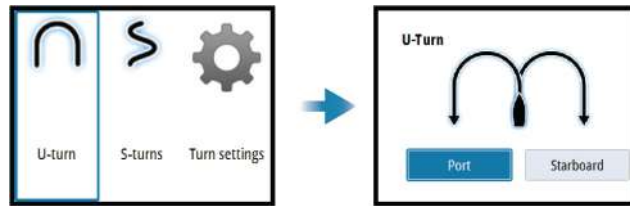

To stop the turn:

- press the Standby key

The autopilot will return to Standby mode and manual steering.

Activating optional turn patterns

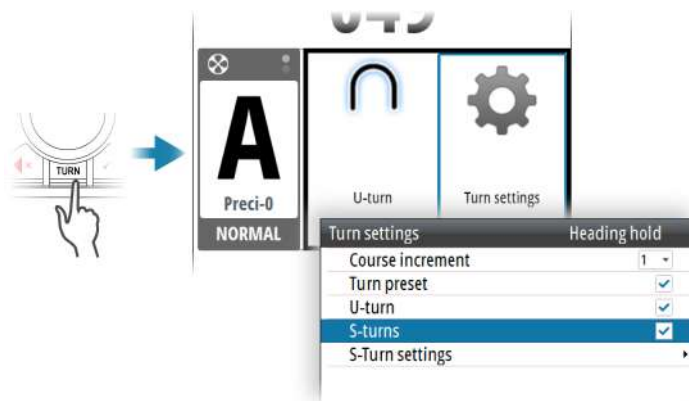

U-turn

Changes the current set heading by 180°. When activated, the autopilot is switched to Auto mode.

The vessel will turn with the defined turn rate or turn radius for active profile. Refer to "Turn" on page 31.

S-turn

Makes the vessel yaw around the main heading. When activated, the autopilot is switched to S-turns mode.

Turn variables:

- Course change
- Turn radius

S-turn settings

The S-turn settings can be set as default values.

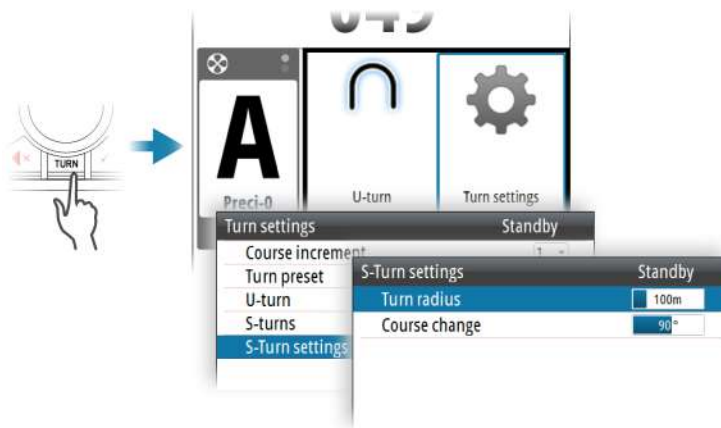

The default values can be changes at any time when the boat is in a turn.

NAV mode

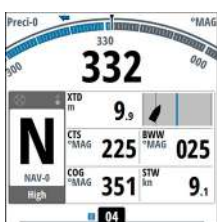

- **Note:** NAV mode requires a compatible navigator connected to the network. It is not possible to select NAV mode if heading information is missing, or if steering information is not received from the external chartplotter.

In NAV mode the autopilot uses steering information from an external navigator to direct the vessel to one specific waypoint location, or through a series of waypoints.

In NAV mode, the autopilot's heading sensor is used as heading source for course keeping. Speed information is taken from SOG or from selected speed sensor. The steering information received from the external navigator alters the set course to direct the vessel to the destination waypoint.

To obtain satisfactory navigation steering, the autopilot system must have valid input from the navigator. Autosteering must be tested and determined satisfactory prior to entering NAV mode.

- **Note:** If the navigator does not transmit a message with bearing to next waypoint, the autopilot will steer using Cross Track Error (XTE) only. In that case you must revert to AUTO mode at each waypoint and manually change set course to equal bearing to next waypoint and then select NAV mode again.

Prior to entering NAV mode the navigator must be navigating a route or towards a waypoint.

- Initiate NAV mode by pressing the **NAV** key
- Confirm to switch to NAV mode in the dialog



Turning in NAV mode

When your vessel reaches a waypoint, the autopilot will give an audible warning and display a dialog with the new course information.

There is a user defined limit for the allowed automatic course change to next waypoint in a route. If the course change is more than this set limit, you are prompted to verify that the upcoming course change is acceptable.

- If the required course change to the next waypoint is less than the course change limit, the autopilot will automatically change the course. The dialog will disappear after 8 seconds unless cleared by the **X** key.

- If the required course change to next waypoint is more than the set limit, you are prompted to verify that the upcoming course change is acceptable. If the turn is not accepted, the vessel will continue with the current set heading.



Course change less than set limit



Course change larger than set limit

Refer to "Course change limit" on page 33.

Track offset

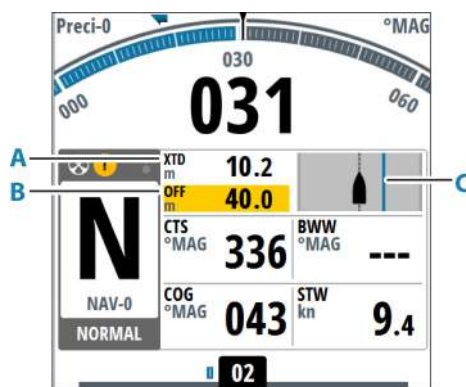

The track offset options allows for steering parallel to the track in NAV mode.

To activate the track offset option:

- press and hold the rotary knob
The display will change to show current distance from track, XTD (A) and set offset, OFF (B)

Turn the rotary knob to adjust the offset distance. The blue line (C) shows the offset in relation to the track.

The system will remain in track offset mode for as long as there is an offset value. It will time out when the offset distance is set to 0 (zero).

Waypoint arrival circle

The arrival circle (radius) defines the point at which a turn is initiated when you are navigating a route.

The arrival circle is set in your chart plotter.

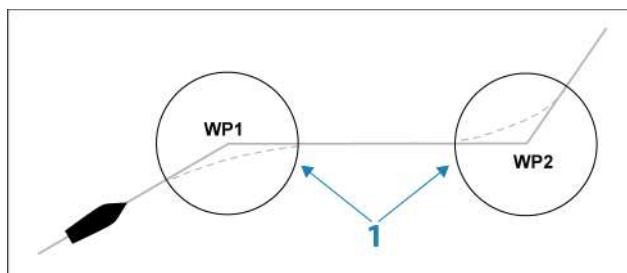

The arrival circle (1) should be adjusted according to boat speed. The higher the speed, the wider the circle. The intention is to make the autopilot start the heading change in due time to make a smooth turn onto the next leg.

The figure below may be used to select the appropriate arrival circle when creating the route.

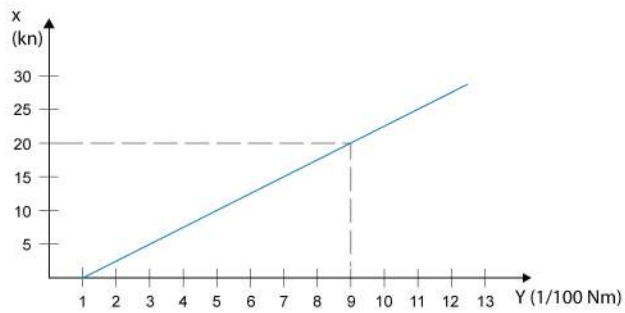

X axis = Boat speed in knots

Y axis = Arrival circle, radius in 1/100 Nm

Example: With the speed of 20 knots you should use a waypoint circle with radius 0.09 Nm.

→ **Note:** The distance between any waypoints in a route must not be smaller than the radius of the arrival circle.

Quick menu in NAV mode



From the Quick menu in NAV mode you can change navigation response and set manual speed.

Controlling steering performance in automatic and navigational modes

The autopilot should be configured during installation and setup.

To increase steering performance, some parameters may be adjusted during operation. The parameters are available from the Quick menu.



Quick menu, Auto mode



Quick menu, Nav and NoDrift mode

Track response

Defines how aggressively the autopilot should steer towards the active route's leg.

Rudder gain

This parameter determines the ratio between commanded rudder and the heading error. The higher rudder gain value the more rudder is applied. If the value is too small it will take a long time to compensate for a heading error, and the autopilot will fail to keep a steady course. If the value is set too high the overshoot will increase and the steering will be unstable.

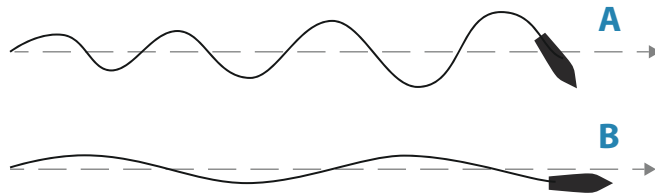

- A** The value is set too high. Steering becomes unstable and often the overshoot will increase
- B** The value is set too low. It will take a long time to compensate for a heading error, and the autopilot will fail to keep a steady course

Counter rudder

Counter rudder is the amount of counteracting (opposite) rudder applied to stop the turn at the end of a major course change. The settings depend on vessel's characteristics, inertia, hull shape and rudder efficiency.

- If the vessel has good dynamic stability, a relatively small value will be sufficient
- An unstable vessel will require high value
- The greater the vessel's inertia, the greater value will be required

Increasing counter rudder value may result in some higher rudder activity also when steering a straight course, particularly in high waves.

The best way of checking the value of the Counter rudder setting is when making turns. The figures illustrate the effects of various Counter Rudder settings.

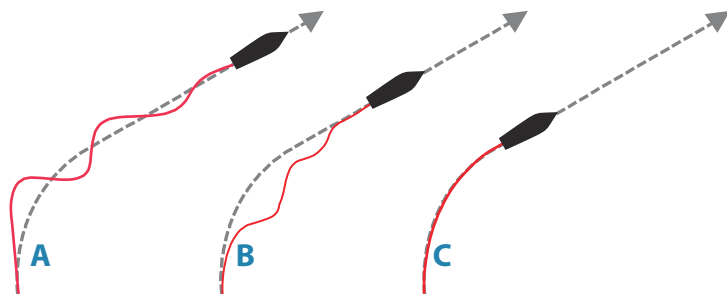

- A** Counter rudder value too low; overshoot response
- B** Counter rudder value is too high; sluggish and creeping response
- C** Correct setting of Counter rudder; ideal response

Perform various course changes and observe how the boat settles on the new heading. Start with small changes, 10-20 degrees, and proceed with bigger changes, 60-90 degrees. Adjust Counter rudder value to obtain best possible response as in illustration **C**.

→ **Note:** As many boats turn differently to port versus starboard (due to propeller rotation direction), do the course changes in both directions. You may end up with a compromise setting of Counter rudder that gives a little overshoot to one side and a bit creeping response to the other.

Speed

If neither boat speed nor SOG data are available and/or deemed unreliable, a manual value for speed can be entered and used by the autopilot to aid steering calculations.

Simulator mode

The simulate option lets you operate the unit without being connected to sensor or other devices.

It is not possible to simulate commissioning and setup.

If the unit is turned off while in simulator mode, this mode will still be active on next power on.

Active simulator mode is indicated with a flashing notification on the image.

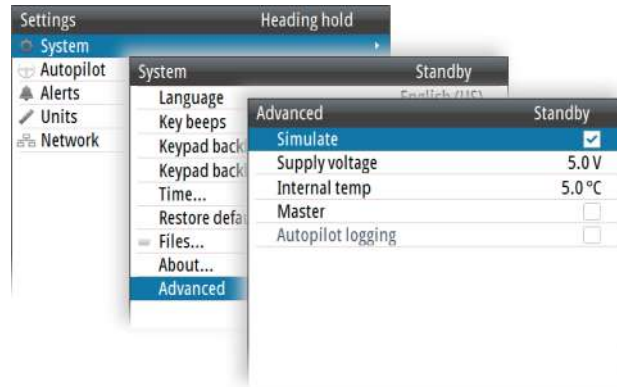

5

Work profiles

A work profile is a set of steering parameters. You can change the active work profile to adapt the autopilot steering characteristics to different operational conditions.

The AP70 MK2 has a set of predefined work profiles, depending on selected boat type. There can be up to 6 work profiles defined in the system.

During commissioning and seatrial the parameters for active profile will be tuned for optimized steering performance.

Predefined profiles

Normal profile

This is the default profile and automatically assigned when you set your vessel type to **Displacement**.

It is recommended to use the Normal profile as a general profile for your vessel. This should be active during the commissioning of your vessel, and all parameter settings will then be saved to this profile.

High and Low profiles

High and Low profiles are automatically assigned when you set your vessel to **Planing**.

The system switches automatically between High and Low profiles based on the vessel's speed and the Transition speed setting. Refer to the separate Installation manual.

Creating a new work profile

New profiles can be defined for operational modes where the vessel's steering parameters deviate from the default profiles.

You can also define a profile for easy access to preferred parameters for various crew members.

1. Press the Work key to display the Work Quick menu
2. Select the Add profile option
3. Select a reference profile that matches the working conditions
 - A new profile must be based on an existing or a predefined work profile. The parameters from the work profile you select as base will be copied to the new profile, and can later be edited
4. - Edit the profile settings as required
5. Complete the task by selecting the Add Profile option



User configurable settings

The steering parameters can be configured differently between the different profiles, depending on boat steering characteristics and user preferences.

The initial parameters are automatically assigned when you select your vessel type. During the seatrial the parameters will be tuned for optimized steering performance.

The options listed in the next pages are available and can be manually adjusted for all profiles.

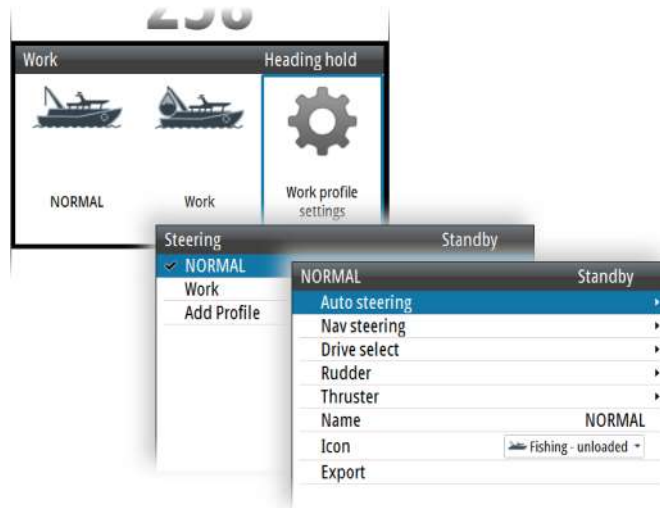

Auto steering

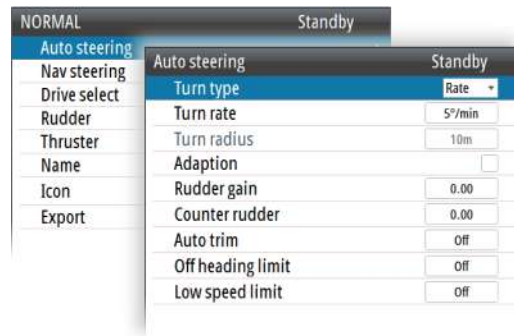

Turn

Used for selecting how you want to control the vessel's turn: either by defining the Rate of Turn (Rate) or the radius.

- Rate range: 5°/minute - 720°/minute
- Radius range: 10 m - 10 NM
 - The minimum radius can however never be less than the value corresponding to a Rate of Turn = 720°/minute at the set Cruising speed

Turn rate

Used for manually setting the turn rate used when the heading change is larger than 5°.

Adaption

When this setting is activated, the autopilot will continuously adapt some steering related parameters to the vessel's behavior. The adapted parameters are stored in the work profile.

Rudder gain

This parameter determines the ratio between commanded rudder and the heading error. The higher rudder gain value the more rudder is applied. If the value is too small it will take a long time to compensate for a heading error, and the autopilot will fail to keep a steady course. If the value is set too high the overshoot will increase and the steering will be unstable.

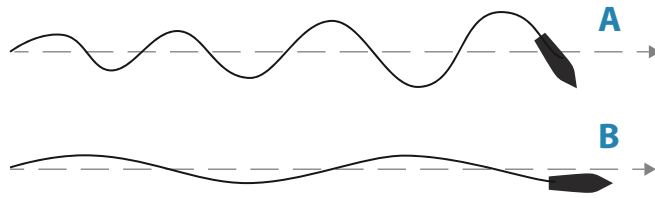

- A** The value is set too high. Steering becomes unstable and often the overshoot will increase
- B** The value is set too low. It will take a long time to compensate for a heading error, and the autopilot will fail to keep a steady course

Counter rudder

Counter rudder is the amount of counteracting (opposite) rudder applied to stop the turn at the end of a major course change. The settings depend on vessel's characteristics, inertia, hull shape and rudder efficiency.

- If the vessel has good dynamic stability, a relatively small value will be sufficient
- An unstable vessel will require high value
- The greater the vessel's inertia, the greater value will be required

Increasing counter rudder value may result in some higher rudder activity also when steering a straight course, particularly in high waves.

The best way of checking the value of the Counter rudder setting is when making turns. The figures illustrate the effects of various Counter Rudder settings.

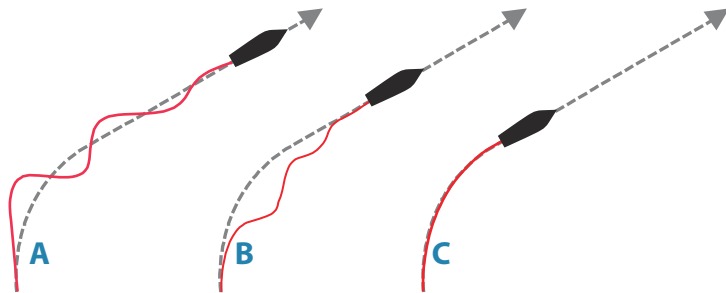

- A** Counter rudder value too low; overshoot response
- B** Counter rudder value is too high; sluggish and creeping response
- C** Correct setting of Counter rudder; ideal response

Perform various course changes and observe how the boat settles on the new heading. Start with small changes, 10-20 degrees, and proceed with bigger changes, 60-90 degrees. Adjust Counter rudder value to obtain best possible response as in illustration **C**.

→ **Note:** As many boats turn differently to port versus starboard (due to propeller rotation direction), do the course changes in both directions. You may end up with a compromise setting of Counter rudder that gives a little overshoot to one side and a bit creeping response to the other.

Autotrim

Controls how fast the autopilot will apply rudder to compensate for a constant heading offset, e.g. when external forces such as wind or current affects the heading. Lower autotrim will give faster elimination of a constant heading offset

Off heading limit

Sets the limit for the off heading alarm.

When the alarm option is activated an alarm occurs when the actual heading deviates from the set heading more than the selected limit.

Low speed limit

Sets the limit for the low vessel speed alarm.

An alarm occurs when the vessel's speed goes below the selected limit.

Nav steering



Nav response

Defines how aggressively the autopilot should steer towards the active route's leg.

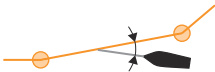

Approach angle

This setting is a limit to prevent approaching the track too steeply. Approaching the track at shallower angles is permitted depending on the cross track distance (XTD) and nav response setting.

This setting is used both when you start navigating and whenever the autopilot is working the boat towards the route.

Course change limit

Defines the limit for automatic course change to next waypoint in a route when the autopilot is following a route (NAV mode).

If the course change is greater than this set limit, you are prompted to verify that the upcoming course change is acceptable.

XTD limit

Defines the vessel's accepted offset distance from the track. If the vessel goes beyond this limit an alarm will be activated.

Drive select

Defines which drives that shall be used for the selected work profile.

Rudder

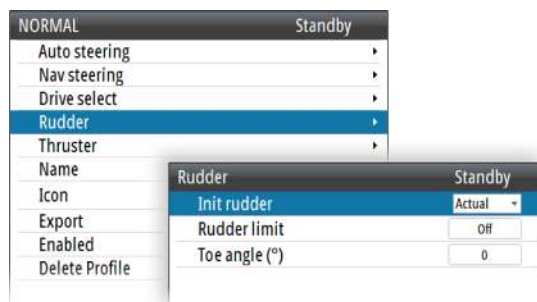

Init rudder

Defines how the system moves the rudder when switching from hand steering (Standby, FU and NFU) to an automatic mode.

The following options are available:

- Center
Moves the rudder to zero position
- Actual
Maintains the rudder angle, and assumes that the current rudder angle is the trim required to maintain a steady heading.

Rudder limit

Determines the dynamic range of the rudder before its movement is restricted and alarm is triggered. Typical usage is to limit the amount of rudder action caused by yawing in following sea.

→ **Note:** Rudder limit is not a hard limitation of the rudder range, only around the current setpoint.

This Rudder limit does not affect Non-Follow-up or Follow Up steering.

Toe angle

This option sets the allowed angle deviation between the rudders. The feature will enhance rudder efficiency at small rudder commands around center position, and it will reduce vibration and/or propeller/water jet noise.

The toe angle is the angle between the rudder's 0-position and the rudder's actual position (t) as shown in the illustration.

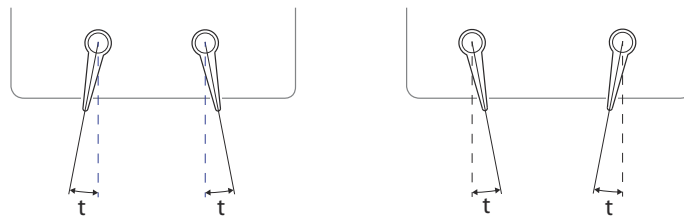

The toe angle will be applied as an offset to each rudder. Toe out (positive value), angles the two rudders apart, while Toe in (negative value) angle them towards center.

→ **Note:**

The toe angle is a work profile setting, and must be enabled for current work profile to be available.

The toe angle is only available if the vessel has 2 rudders. It applies only to rudders located on the side of the ship - it will have no effect on a rudder located in the ship center.

The toe angle is effecting all operating modes except Standby and NFU.

When the feature is enabled, one rudder will stop moving before the other one if max./min. rudder angles are demanded.

When the feature is enabled, the rudder bar shows rudder command instead of measured rudder angle.

Thruster

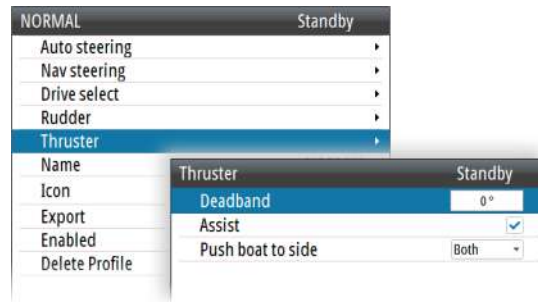

Deadband

Determines how many degrees the vessel must deviate from the set course before a thruster command is given. As the vessel deviates from its heading, the thruster will push the vessel back.

A higher value will reduce the thruster activity and extend the lifetime, especially for on/off thrusters.

Assist

Determines how the thrusters are used by the autopilot.

When set to ON, the thrusters will automatically be used by the autopilot system if the vessel speed is below inhibited limit. If the vessel speed is above inhibited thruster speed the thrusters will be turned off, but will automatically be turned on again when the speed goes below the inhibited limit.

→ **Note:** Thruster inhibit speed is set during installation and is the max. vessel speed for which the thruster is allowed to run.

When set to OFF, thruster has to be manually enabled.

Push boat to

Used for specifying if the thruster should be used for course deviations to port only, starboard only, or for any course deviation.

Work profile name

Set the name to identify the profile.

→ **Note:** You can use several characters for the profile name, but only the first 6 characters will be shown as profile name.

Profile icon

The system includes a number of icons that can be used to identify the profile settings.

Exporting and importing work profiles

It is possible to export and import a work profile to/from a USB stick.

6

The alert system

The system continuously checks for dangerous situations and system faults while running.

Alert message types

There are two types of messages:

- Alarms
 - Generated when conditions are detected that may critically effect the capability or performance of the system. You must critically examine all alarm messages to determine their cause and effect
- Warnings
 - Informing you of conditions that could result in unwanted system response or possible failure

Alert indication

When an alert situation occurs, a siren will sound and the alert icon will become active. The alert pop-up will show alert cause, followed by the name of the device that generated the alert.







A single alert is displayed with the name of the alert as the title, and with details for the alarm. If more than one alert is activated simultaneously, the alert pop-up can display multiple alerts. The alerts are listed in the order they occur with the alert activated first at the top. The remaining alerts are available in the Active alerts dialog.

Alert icons

The alert icon will remain in the status panel until the alert is acknowledged and rectified. The table below shows alert icon and behavior depending on if the alert is active, acknowledged, transferred or rectified.



Type	Icon	State	Indication
Alarm		Active - not acknowledged, not silenced	<ul style="list-style-type: none">• Descriptive text• Audible signal
		Active - not acknowledged, silenced	<ul style="list-style-type: none">• Descriptive text• No audible signal
		Active - acknowledged	<ul style="list-style-type: none">• Descriptive text• No audible signal
		Rectified - not acknowledged	<ul style="list-style-type: none">• Descriptive text• No audible signal

Type	Icon	State	Indication
Warning		Active - not acknowledged, not silenced	<ul style="list-style-type: none"> • Descriptive text • Audible signal
		Active - not acknowledged, silenced	<ul style="list-style-type: none"> • Descriptive text • No audible signal
		Active - acknowledged	<ul style="list-style-type: none"> • Descriptive text • No audible signal
		Rectified - not acknowledged	<ul style="list-style-type: none"> • Descriptive text • No audible signal

Acknowledging a message

An alert dialog showing a single message have one or two options for acknowledging the message:

- ACK / Acknowledge
Sets the alarm state to acknowledged, meaning that you are aware of the alarm condition. The siren/buzzer stops and the alarm dialog is removed. However, the alarm remains active in the alarm listing until the reason for the alarm has been removed.
- Silence
Mutes the siren locally (for 30 seconds) for all units in the same network alarm group. The alert dialog remains on the display.



There is no time-out on the alarm message or siren. They remain active until you acknowledge the alarm or until the reason for the alarm is removed.

Alert dialogs



Active alerts

List of all active alerts.

Alert history

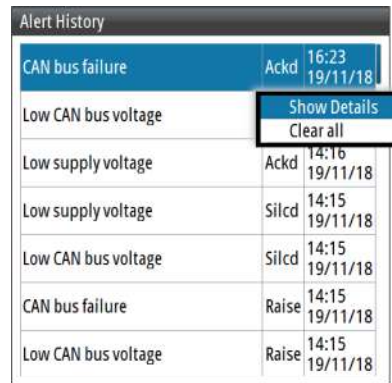

Alert History		
CAN bus failure	Ackd	16:23 19/11/18
Low CAN bus voltage		
Low supply voltage	Ackd	14:16 19/11/18
Low supply voltage	Silcd	14:15 19/11/18
Low CAN bus voltage	Silcd	14:15 19/11/18
CAN bus failure	Raise	14:15 19/11/18
Low CAN bus voltage	Raise	14:15 19/11/18

Alert events, including alert type, status and time/date

The Alert history dialog stores all alerts, including status and time/date. The alerts remain in the dialog until they are manually cleared.

To show alert details or to clear all alerts:

- Press the menu key and select the desired action

Alert setting

List of all alerts that can be enabled and configured by the user.

Setting the alert and warning limits



Most autopilot alerts are activated based on pre-set alert limits, and these limits be changed by the user.

The following setting(s) are common for all work profiles. For work profile specific settings, refer to "*Work profiles*" on page 30.

Compass difference limit

When two compasses are used (main compass and monitor compass), there is virtually always a difference between the readings of the two. If the difference exceeds the set limit, an alarm is given.

- **Note:** The difference between the two compass readings may vary with the vessel's heading and from one area to another where a vessel is in transit. The difference between the two compass readings is automatically reset when a Compass difference alarm is acknowledged.

Fallback and failures during automatic steering

Rudder data missing

Alarm will be given, and steering will after 0.1 sec continue using virtual (estimated value based on known rudder speed) rudder angle data.

Steering compass missing

When monitor compass is available

Alarm for main compass failure is given and steering continues using monitor compass. If there is a difference between the compasses, a smooth transition (2 min. filter) to the

monitor compass heading takes place. When acknowledging the alarm, the autopilot goes to Standby mode.

When monitor compass is not available

Rudder is kept at fixed angle (i.e. heading is approximately maintained if failing when heading keeping, turn is approximately maintained if failing when turning), alarm is given and autopilot goes to Standby mode.

Magnetic variation missing

If heading source is set to be adjusted for magnetic variation, variation is taken from available sensors in following order:

- position source
- navigation source
- compass
- any other variation available on CAN bus.

If variation disappears, last valid variation will be used until automatic steering is cancelled and heading shown will then be corrected according to alternative variation in the order given above.

Jump in heading data, check heading

If there is an abnormal heading jump in steering compass heading, an alarm will be given and a smooth transition to new heading will take place. There may also be a compass difference alarm if a monitor compass is in use.

Boat speed missing

If speed in use is lost, there will be an alarm and smooth transition (2 min. filter) to fallback speed. Speed for steering and speed for navigation will use following priority and fallback:

Steering

- STW
- STW backup
- SOG
- SOG backup
- Manual speed
- Cruising speed

Navigation

- SOG
- SOG backup
- STW
- STW backup
- Manual speed
- Cruising speed

Position data missing

During NoDrift steering, alarm is given and a smooth transition to position backup source takes place. If there is no position backup steering source, steering mode will change to auto heading.

Navigation data missing

If lost during Nav. steering, an alarm will sound and steering will change to auto heading steering.

Local supply voltage missing

When control unit(s) and CAN bus have different power source, alarm will be given on active control unit with sound and flashing red power button led (display will go "black"). Main steering computer will go to Standby mode and activate alarm on all other control units.

CAN bus supply voltage missing

Active control unit will give local alarm and rudder/thruster drive units will go to Standby mode.

Autopilot computer missing rudder/thruster drive computer failure

Alarm will be given and the ready signal to the steering /thruster gear will disappear. If software failure, there will be a watchdog restart of failing drive computer. The autopilot steering computer will try to maintain steering as far as possible with remaining drive computers. If the faulty unit is the autopilot steering computer, autopilot backup computer has to be selected manually.

Possible alerts and corrective action

The next pages include a list of all alerts generated by the autopilot system.

The unit might also display alerts received from other units connected to the system. Refer separate documentation for the relevant equipment for further description of these alerts.

Alert type abbreviations:

- **A:** Alarm
- **W:** Warning

Active control unit missing (A)

Autopilot computer has lost contact with active control unit.

- Check/repair CAN bus cable
- Replace the control unit

Autopilot computer missing (A)

Active control unit has lost contact with autopilot computer.

- Check connectors and cables
- Replace autopilot computer

→ **Note:** This alarm will only show up on passive units if active control unit is defective or has lost bus communication.

Boat speed missing (W/A)

(Alarm when Nav steering, else Warning).

The speed signal from the GPS or the log is missing.

- Check device list for valid speed source
- Try a new automatic source update
- Check the GPS, log, and cable connections

CAN bus failure (W/A)

(Warning in standby mode, else Alarm)

Poor CAN bus backbone, defective cable/connector or defective CAN bus receiver in autopilot control head.

- Check backbone terminations
- Check cable and connectors
- Replace autopilot control unit

CAN bus supply overload (W/A)

(Warning if current is >4.3 A. Alarm if current >10 A for 1 ms, hw shutdown).

Excessive current draw.

- Check summary unit loads
- Check for short circuit/defective device on network

Check heading (W)

Jump in heading of more than 10°/second.

- Check steering compass
- Change to other heading source or monitor compass

Compass difference (W)

The difference in readings between the main compass and the monitor compass exceeds the limit set for compass difference.

- Check the operation of both compasses. If one compass is magnetic, the error may be caused by deviation change or heavy sea disturbances

Course difference (W)

Compass heading is deviating too much from the track course (BWW). May be caused by extreme wind and current, combined with low speed.

Cross track distance limit (W/A)

(Alarm when track steering, else Warning).

XTD exceeds the set XTD limit in NAV mode. May be caused by extreme wind and current or too low boat speed.

Drive inhibit (A)

Motor or solenoid drive electronics critically overloaded.

- Check connectors and cables

Drive not available

No drive response when requested from autopilot on Handshake port on SD80/AD80 board.

- Check that steering gear/thruster is set for autopilot control
- Check cabling to Handshake port on SD80/AD80 board
- Make sure Handshake port on SD80/AD80 board is configured for HS fixed/HS pulse (refer to the configuration section in the Installation manual).

Drive overload (W/A)

(Warning if motor/solenoid current > 30 A (AC70) or solenoid current >8 A (SD80). Alarm if motor/solenoid current > 55 A (AC70) or solenoid current >9 A (SD80)).

Reversible motor: motor stalls or is overloaded. Solenoids: shortage to ground or cabling damage.

- Fix possible mechanical blocking of rudder
- If heavy sea at high rudder angle, try to reduce boat speed or rudder angle by steering at another heading
- Make sure there is no shortage to ground or cabling damage
- Disconnect cable from autopilot computer to motor, and make sure there is no alarm when trying to run in NFU mode

Drive reference voltage missing (A)

Reference voltage to AD80 is missing.

- Check that the two U_CTRL dip switches on the AD80 board is set correctly (ref. cable connection label inside faulty unit)
 - If drive control signal is 4-20 mA current or voltage using internal ± 10 V reference, switches must be set to INT
 - If external ref. voltage is connected switches must be set to EXT
- If external reference voltage, check cabling and measure correct voltage between U_REF+ and U_REF- on AD80 board

Drive unit failure (W/A)

The autopilot computer has lost communication with device.

- Check that green CPU led on the AC70 is alternating (ref. label inside unit cover for location of led)
 - If off, check local power supply/fuse
- For AD80/SD80, check CAN supply for 9-15 V between NET-S and NET-C of SimNet plug
 - If LED is ok, check cabling, T-connector backbone etc
 - If LED is on, try to restart unit by turning power off/on

End of route (A)

Activated on the active control unit when an end route waypoint name has been received from the Plotter/ECS.

Engage output overload (W/A)

(Warning when current >3.5 A. Alarm when current > 5 A).

Bypass valve or clutch is drawing excessive current.

- Ensure there is no shortage to ground or cabling damage
- Disconnect cable from autopilot computer to motor, and make sure there is no alarm when engaging FU or AUTO mode

EVC Com error (A)

Lost communication with EVC system (Volvo IPS and similar).

- Check connection with EVC engine interface. For IPS, engine must be running

External mode illegal (A)

Signals to external mode input port on AD80/SD80 has illegal combination.

- Check if alarm is given for a certain position of external mode selector
- Check cabling to MODE SEL port on the AD80/SD80 board

High drive temp. (W/A)

(Warning if drive electronic temperature >80°C. Alarm if drive electronic temperature close to 120°C for more than 1 second).

- Switch off autopilot
- Check for backload in drive unit/steering system
- Check that the autopilot computer specifications matches drive unit

High internal temp (W)

Internal temperature >75°C.

Low boat speed (W/A)

(Alarm when track steering, else warning if speed data is used for steering).

Speed below set limit for acceptable course keeping (in Work profile).

- Switch to hand steering or adjust Work profile settings

Low CAN bus voltage (W)

CAN bus voltage < 9 V.

- Check cable length, bus load and bus supply feeding point. If possible, check if fault disappears by disconnecting some units

Low supply voltage (W)

Supply voltage <9.5 V.

- Check battery/charger condition
- Verify mains cable has correct gauge

Monitor compass missing (W)

No data from the selected monitor compass.

Nav data missing (W/A)

(Alarm if sensor data is used for steering. Warning if missing when starting NAV mode).

Navigation data from Plotter/ECS missing.

- Check device list for valid navigation source
- Try a new automatic source update
- Check the Plotter/ECS and cable connections

New WP (A)

Nav mode only.

Course change from one leg to the next is exceeding set "Course change limit".

No rudder response (A)

No response to rudder command.

- Check all connections
- Check rudder feedback transmission link (not applicable for Virtual feedback installations)
- Check drive unit motor/brushes
- For SD80, check that port/stbd led is activated (ref label in cover for location)

- Replace the autopilot computer drive board

Off heading (W)

The vessel heading is outside set off heading limit. May be caused by extreme weather conditions, and/or too slow speed.

- Check steering parameters (Rudder, Autotrim, Seastate filter)
- Increase response/rudder value
- Increase boat speed, if possible, or steer by hand

Override (W)

EVC override via SG05, override via SD80/AD80 Handshake or override via SD80/AD80 RUD UI port.

- If unintended warning, make sure override handle is not being activated by loose objects
- Check cabling and override switches connected to Handshake port of SD80 or AD80 board

Position data missing (W/A)

(Alarm in NoDrift mode, else Warning).

Position data from the GPS is missing.

- Check device list for valid position source
- Try a new automatic source update
- Check the GPS and cable connections

Rudder data missing (A)

Rudder angle signal to autopilot computer is missing.

- If several rudder angle sensors, check which port on the board that is set up for use
- If the missing sensor is connected to an autopilot computer, check cabling
- If missing sensor is a CAN device, check network connection

Rudder limit (W)

The set rudder limit has been reached or is exceeded. Might be caused by disturbance to compass (waves) speed log, sharp turn or improper parameter settings.

This warning is related to rudder command in automatic modes. The warning is automatically reset when the rudder position is within the limits.

Rudder too slow (W)

Excessive load to steering gear. Air in hydraulic system, insufficient drive unit capacity.

- Look for mechanical obstructions at the rudder/tiller/ quadrant. Check the back drive force
- Bleed the hydraulic system
- Replace with larger pump unit

Sharp turn (W)

Acceleration is larger than the set Sharp turn limit.

- check that the vessel speed to the autopilot is correct
- check that the set turn rate or radius corresponds to actual turn rate

Steering compass missing (A)

No data from the selected steering compass.

If no monitor (back-up) compass: the autopilot goes to Standby mode.

If monitor compass: the autopilot goes to monitor compass.

If there is a difference, the autopilot will gradually synchronize with the new heading (2 minutes).

Thruster inhibited (W)

The vessel speed exceed the set limit for when the thruster can be used.

- **Note:** The Thruster inhibit limit will only apply when speed source is Log or SOG, not if the speed is set manually.

7

Maintenance

Preventive maintenance

The unit does not contain any field serviceable components. Therefore, the operator is required to perform only a very limited amount of preventative maintenance.

Cleaning the display unit

To clean the screen:

- A micro-fiber or a soft cotton cloth should be used to clean the screen. Use plenty of water to dissolve and take away salt remains. Crystallized salt, sand, dirt, etc. can scratch the protective coating if using a damp cloth. Use a light fresh water spray then wipe the unit dry with a micro-fiber or a soft cotton cloth. Do not apply pressure with the cloth.

To clean the housing:

- Use warm water with a dash of liquid dish soap or detergent.

Avoid using abrasive cleaning products or products containing solvents (acetone, mineral turpentine, etc.), acid, ammonia, or alcohol as they can damage the display and plastic housing.

Do not:

- use a jet or high pressure wash

Cleaning the media port door

Clean the media port door regularly to avoid salt crystallization on the surface, causing water to leak into the card slot.

Checking the connectors

Push the connector plugs into the connector. If the connector plugs are equipped with a lock or a position key, ensure that it is in the correct position.

Restoring factory default settings

A default restore will reset the memory to factory settings.

- **Note:** Unless you need to clear all stored values during the installation setup procedure, you should not perform a restore of factory settings.



Backup and restore of system data

The system includes a backup and restore function, making it possible to back-up and restore user settings.

→ **Note:** It is strongly recommended to make a backup when the system is installed and configured.

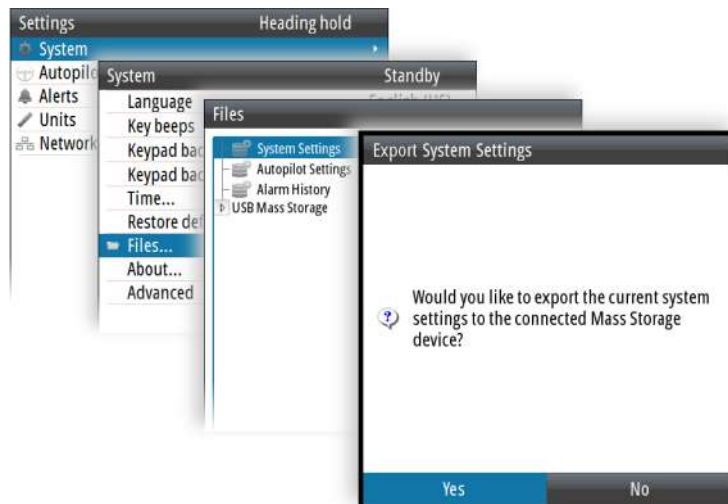

Software updates

Before initiating an update to the unit, be sure to back up any potentially valuable user data. Refer to "*Backup and restore of system data*" on page 44.

Installed software and software updates

The about dialog shows the software version currently installed on this unit (A).

The product website has information about available software updates.



Update the software from a storage device

You can download the software update from www.navico.com/commercial.

Transfer the update file(s) to a compatible storage device, and then insert the storage device in the unit.

To update this unit only:

- restart the unit to start the update from the storage device

To update this unit or a connected device:

- Select the update file in the dialog

→ **Note:** Do not turn off the unit or a connected device until the update is completed, or until you are prompted to restart the unit.

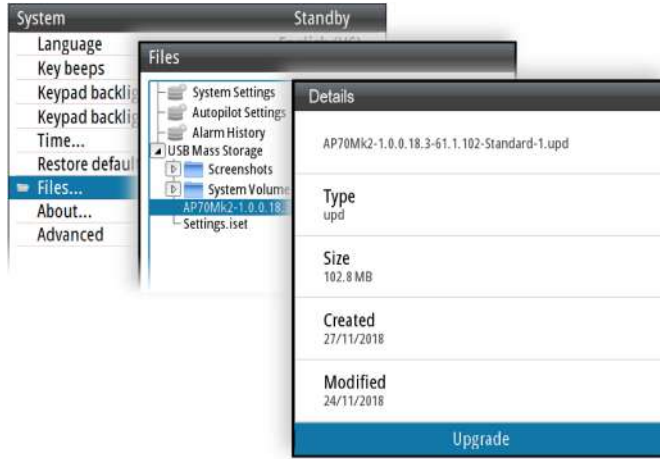

8

Menu overview

Quick menus

The Quick menus are mode dependant, and contain the most commonly used settings for the active mode. Each Quick menu have access to the Settings menus.

To access the Quick menu:

- press the Menu key.

Quick menu in manual modes

The menu options are described in *"Quick menus in STBY, FU and NFU mode"* on page 20.

Level 1	Level 2
Sources	Auto select
	Steering compass >
	Navigation >
	Position >
	Boat speed >
	Depth >
	Autopilot computer >
	Monitor compass >
	Position backup >
	Boat speed backup >
	Autopilot computer backup >
Alerts	Active alerts...
	Alert history...
	Alert settings
Speed (Adjust)	

Quick menus in automatic and navigational mode

These menu options are used for manually adjusting steering performance.

The menu options are described in *"Controlling steering performance in automatic and navigational modes"* on page 27.

Auto mode

Level 1	Level 2
Rudder (Adjust)	
Counter rudder (Adjust)	
Speed (Adjust)	
Settings	(Settings dialogs/menus)

NoDrift and Nav mode

Level 1	Level 2
Track response (Adjust)	
Rudder (Adjust)	
Counter rudder (Adjust)	
Speed (Adjust)	
Settings	(Settings dialogs/menus)

Settings

During installation the system is configured, most system settings are defined, and the system is commissioned. All system configuration and Installation setup is described in the separate AP70 MK2 Installation manual.

To access the Settings menu:

- press the Menu key twice.

Level 1	Level 2	Level 3
System	Language	
	Key beeps	
	Keypad backlight day color	White/Red
	Keypad backlight night color	Red/White
	Time...	
	Restore defaults	Autopilot drive settings
		Global settings
		Alert history
		Local settings
	Files	
	About	
	Advanced >	Simulate
		Voltage
		Master
		Status output
Autopilot	Installation >	Dockside drives >
		Dockside boat >
		Autopilot source >
		Compass calibration ... >
		Sea trial ...
	Steering >	(Access to settings for available work profiles)
	Turn settings >	Course increment
		Turn preset
		U-turn (Enable/Disable)
		S-turns (Enable/Disable)
		S-Turn settings >

Level 1	Level 2	Level 3	
Alerts	Active alerts...		
	Alert history...		
	Alert settings >	Compass difference limit	
Units	Distance		
	Distance small		
	Speed		
	Heading		
Network	Sources >	Auto select	
		Steering compass >	
		Navigation >	
		Position >	
		Boat speed >	
		Depth >	
		Autopilot computer >	
		Device list...	
		Diagnostics	
		Groups >	Display
			Units
			Damping
			Station
		Damping >	Heading
			Boat speed
			SOG
			COG

9

Terms and abbreviations

The following tables holds a list of abbreviations used in the autopilot display.

BWW	Bearing Waypoint To Waypoint
COG	Course Over Ground
CTS	Course To Steer
CRS	Course
DTW	Distance to next waypoint
FU	Follow-Up mode
NFU	Non Follow-Up mode
HDG	Heading
MAG	Magnetic
SOG	Speed Over Ground
STW	Speed Through Water
WPT	Waypoint name or number
XTD	Cross track distance



SIMRAD